



TRAVIS INDUSTRIES
HOUSE OF FIRE

Wood Stove 400cfm Blower (Version 2) Installation Instructions (SKU 99000144)

Compatibility

- Cape Cod (SN 1113-002411 or greater)*
- Evergreen
- Rockport
- Endeavor NexGen™
- Liberty NexGen™

***NOTE:** For Cape Cod serial numbers before SN 1113-002411, in addition to this fan kit, you need to order "Convection Cover Retrofit Kit" (sku# **250-03654**)

Electrical Details

120 VAC, Max 1.5 Amp

Packing List

- Magnetic Rheostat Assembly
- Convection Blower
- Junction Box Bracket
- Snap Disc Bracket
- Extension Ring
- Hardware Pack:
 - (4) 10-24 X 7/8" Screws
 - (3) #8 X 3/8" Screws
 - (4) #10 Washers
 - (1) 1/2" Loop Clamp
 - (1) Self-drilling screw
 - Wire Loom





Wood Stove 400cfm Blower (Version 2) Installation Instructions (SKU 99000144)

Installation

1. Use wire cutters to remove one of the tabs securing the blower knock-out in place.

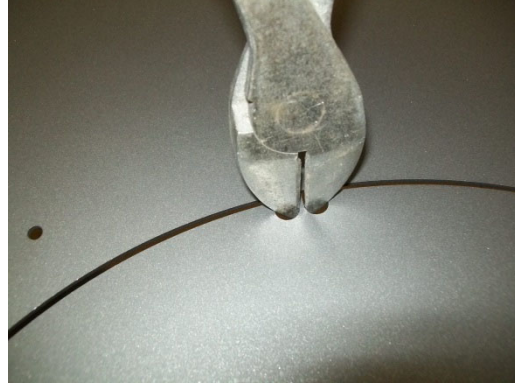
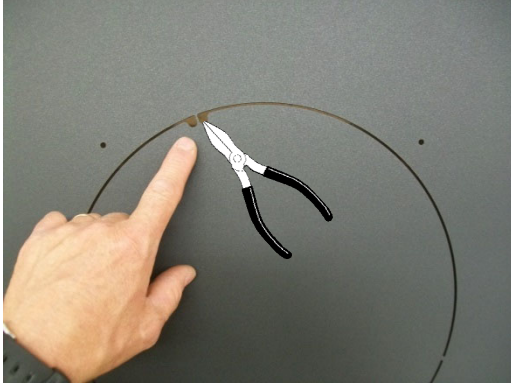

2. Press on opposite sides of the knockout repeatedly to weaken the remaining tabs holding the knock-out in place. Once loose, remove and discard the knock-out.

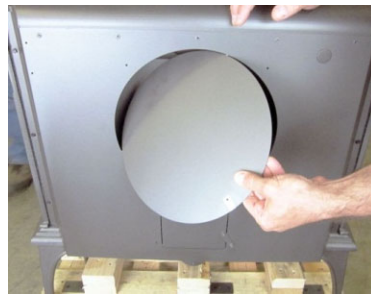



TRAVIS INDUSTRIES
HOUSE OF FIRE

Wood Stove 400cfm Blower (Version 2) Installation Instructions (SKU 99000144)

3. The junction box bracket is shipped in the Cape Cod / Rockport configuration (note 45° angle). If installing on an Evergreen, Endeavor, or Liberty, bend the 45° angle flat as shown below.

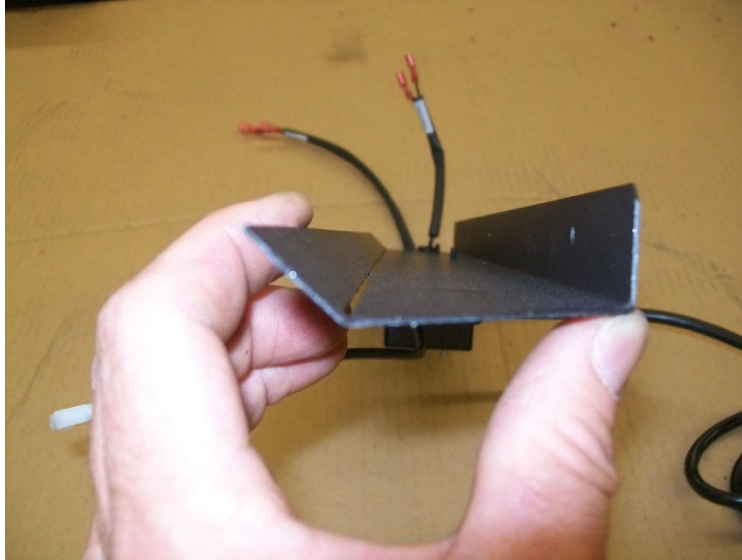

Cape Cod / Rockport Configuration

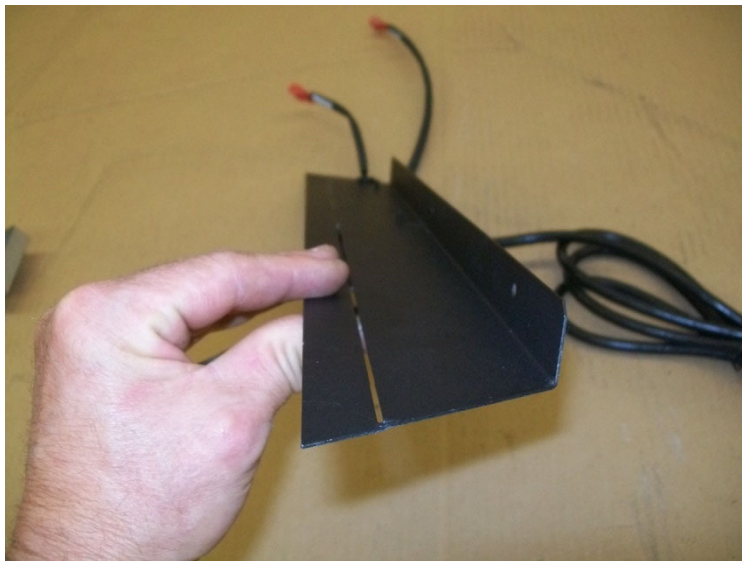

Evergreen / Endeavor / Liberty Configuration



Wood Stove 400cfm Blower (Version 2) Installation Instructions (SKU 99000144)

4. Attach the snap disc bracket to the junction box bracket as shown below. The two #8 x 3/8" screws are shipped pre-threaded into the snap-disk bracket.

Note the location and orientation of the snap-disk bracket. It is located on the power cord end of the junction box bracket, and must be attached so the lip of the junction box bracket is positioned as shown in the photo below.

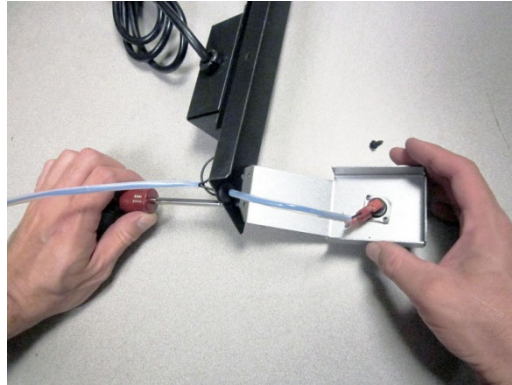

5. Attach the junction box bracket to the bottom rear of the stove with three #8 X 3/8" screws.

NOTE: Make sure the snap disc contacts the back wall of the stove. If it does not, bend the snap disc bracket to ensure proper contact.

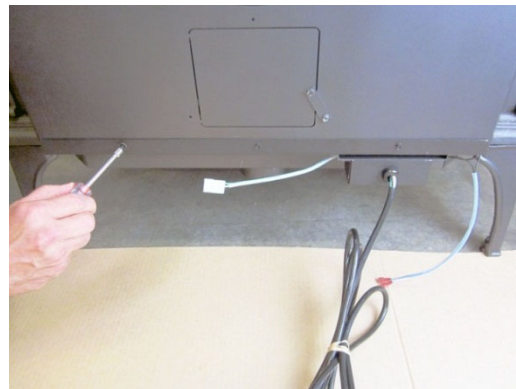



Wood Stove 400cfm Blower (Version 2) Installation Instructions (SKU 99000144)

- Secure the blower assembly and extension ring to the stove using a 5/16" nut driver and the included (4) 10-24 X 7/8" screws and #10 washers (see illustration below).

NOTE: The extension ring sit proud of the rear of the stove and fills the small gap between the blower and the back of the stove so that debris cannot contact the fan blades. If the ring does not sit proud of the rear of the stove, turn it over and reinstall.

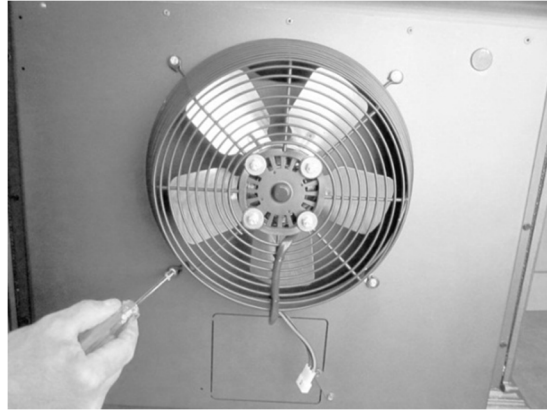
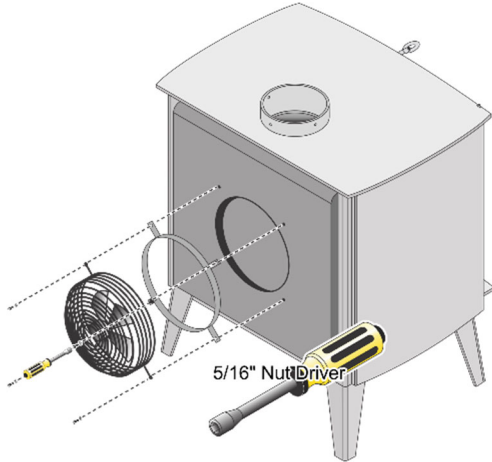

- Connect the blower wires to the wires from the junction box bracket.

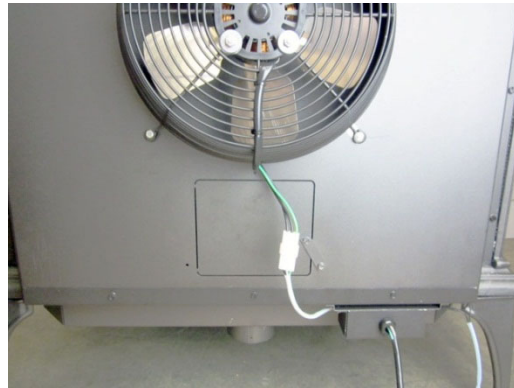
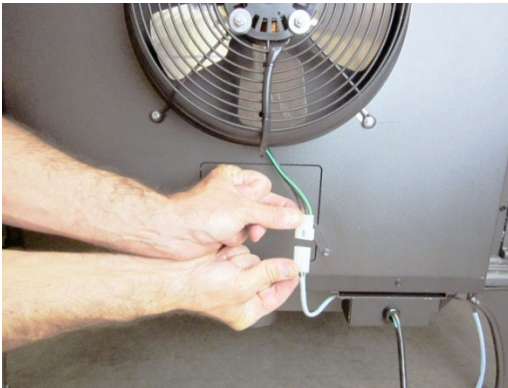

- Attach the wire loom over the wires and molex connection to conceal and protect the wiring.





Wood Stove 400cfm Blower (Version 2) Installation Instructions (SKU 99000144)

9. Attach the Rheostat to the left underside of the stove behind the pedistal mount or front leg and connect the rheostat wires to the wires marked "Rheostat" coming from the junction box bracket.



10. Place the loop clamp over the rheostat wires.



Cape Cod / Rockport



Evergreen / Endeavor / Liberty

11. Secure the clamp to the bottom of the stove using the self drilling screw.



Cape Cod / Rockport Wire Clamp Location



Evergreen / Endeavor / Liberty Wire Clamp Location

12. Before plugging in the blower, verify all electrical wires and components are intact and do not contact any hot or moving components.