

ProBuilder 36/42 CleanFace GSB2 Owner's Manual



⚠ WARNING: FIRE OR EXPLOSION HAZARD

Failure to follow safety warnings exactly could result in serious injury, death, or property damage.

- Do not store or use gasoline or other flammable vapors and liquids in the vicinity of this or any other appliance.
- **WHAT TO DO IF YOU SMELL GAS**
 - Do not try to light any appliance.
 - Do not touch any electrical switch; do not use any phone in your building.
 - Leave the building immediately
 - Immediately call your gas supplier from a neighbor's phone. Follow the gas supplier's instructions.
 - If you cannot reach your gas supplier, call the fire department.
- Installation and service must be performed by a qualified installer, service agency or the gas supplier.



**HOT GLASS WILL CAUSE
BURNS**

**DO NOT TOUCH GLASS
UNTIL COOLED**

**NEVER ALLOW CHILDREN
TO TOUCH GLASS**

A barrier designed to reduce the risk of burns from the hot viewing glass is provided with this appliance and shall be installed for the protection of children and other at-risk individuals.

Tested and Listed by



Report # 0028GF115S
Omni-Test Laboratories, Inc.
Portland, Oregon
ANSI Z21.88-2016
CSA 2.33-2016
CSA 2.17-2017

- Operation
- Maintenance

**This appliance may be installed in an aftermarket, permanently located, manufactured home (USA only) or mobile home, where not prohibited by local codes.
This appliance is only for use with the type of gas indicated on the rating plate. A conversion kit is supplied with the appliance.**

INSTALLER: Leave this manual with the appliance.

CONSUMER: Retain this manual for future reference.

Introduction

We welcome you as a new owner of a ProBuilder GSB2 gas fireplace. This manual details operation and maintenance of this fireplace. Please familiarize yourself with the Owner's Manual before operating your heater and save the manual for future reference.

Important Information

No other ProBuilder gas fireplace has the same serial number as yours. The serial number is on the listing label that is chained to the gas control valve. This serial number may be needed in case you require service.

Model: ProBuilder 36 CF GSB2

ProBuilder 42 CF GSB2

Serial Number: _____

Purchase Date: _____

Purchased From: _____

Register your warranty online at:

traviswarranty.com

Save Your Bill of Sale.

To receive full warranty coverage, you will need to show evidence of the date you purchased your heater.

We suggest that you attach your Bill of Sale to this page so that you will have all the information you need in one place should the need for service or information occur.

Installation Warnings

- Installation requirements are printed in the ProBuilder GSB2 Installation Manual. All requirements in the installation manual must be met.
- Failure to follow all of the requirements may result in property damage, bodily injury, or even death.
- This heater must be installed by a qualified installer who has gone through a training program for the installation of direct vent gas appliances.
- This appliance must be installed in accordance with all local codes, if any; if not, follow ANSI Z223.1 and NFPA 54(88). In Australia follow AS/NZS 5601.1.
- In Manufactured or Mobile Homes must conform with Manufactured Home Construction and Safety Standard, Title 24 CFR, Part 3280, or, when such a standard is not applicable, the Standard for Manufactured Home Installations, ANSI/NCSCS A225.1. This appliance may be installed in Manufactured Housing only after the home is site located.
- The fireplace is designed to operate on natural gas, or propane (LP).
- All exhaust gases must be vented outside the structure of the living-area. Combustion air is drawn from outside the living-area structure.
- Notify your insurance company before hooking up this fireplace.

Table of Contents

Introduction	2	Adjusting the Blower Speed (Optional)	10
Important Information	2	Normal Operating Odors	10
Installation Warnings	2	Power Outages	10
Table of Contents	3	Glass Frame Removal and Installation	11
Features	3	PB 36 Log Set Installation	14
Heating Specifications	3	<i>PB 42 Log Set Installation</i>	20
Before You Begin	6	Maintaining Your Heater's Appearance	27
Location of Controls	6	Yearly Service Procedure	28
Starting the Fireplace for the First Time	7	Troubleshooting Table	29
Turning the Fireplace On and Off	7	Replacement Parts List	30
Adjusting the Flame Height	8	Wiring Diagram	31
Adjusting the Blower Speed (Optional)	8	36 CF Safety Label	32
Continuous Pilot / GreenSmart™ Pilot		42 CF Safety Label	33
Switch	8	CONDITIONS & EXCLUSIONS	34
Pilot Fuel Conservation Timer	9	IF WARRANTY SERVICE IS NEEDED:	34
Starting the Heater for the First Time	10	Index	36

Features

- Works During Power Outages
- Contemporary Look
- Optional Blower for Heat Distribution
- Optional Remote Thermostat
- Standing Pilot
- Standing or Intermittent (GreenSmart) Pilot
- Variable-Rate Heat Output
- Low Maintenance

Heating Specifications

		Natural Gas	Propane
ProBuilder 36 CF	Approximate Heating Capacity (in square feet)*	Up to 1,150	Up to 1,150
	Maximum BTU Input Per Hour	25,000	24,000
ProBuilder 42 CF	Approximate Heating Capacity (in square feet)*	Up to 1,750	Up to 1,750
	Maximum BTU Input Per Hour	35,000	35,000

* Heating capacity will vary with floor plan, insulation, and outside temperature.

**IF YOU SMELL GAS:**

- * Do not light any appliance
- * Extinguish any open flame
- * Do not touch any electrical switch or plug or unplug anything
- * Open windows and vacate building
- * Call gas supplier from neighbor's house, if not reached, call fire department



This unit must be installed by a qualified installer to prevent the possibility of an explosion. Your dealer will know the requirements in your area and can inform you of those people considered qualified. The room heater should be inspected and cleaned before use and at least annually by a qualified service person. More frequent cleaning may be required due to excessive lint from carpeting, bedding material, etc.

The instructions in this manual must be strictly adhered to. Do not use makeshift methods or compromise in the installation. Improper installation will void the warranty and safety listing.

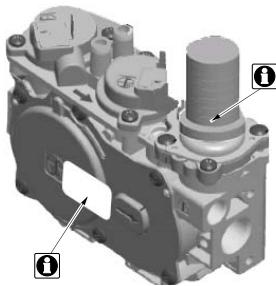

This heater is either approved for natural gas (NG) or for propane (LP). Burning the incorrect fuel will void the warranty and safety listing and may cause an extreme safety hazard. Direct questions about the type of fuel used to your dealer. Check for a label on the flame adjust knob on the gas control valve (this is the best place to check). You may also check for a label on the gas control valve body.



Contact your local building officials to obtain a permit and information on any installation restrictions or inspection requirements in your area. Notify your insurance company of this heater as well.



If the flame becomes sooty, dark orange in color, or extremely tall, do not operate the heater. Call your dealer and arrange for proper servicing.



It is imperative that control compartments, screens, or circulating air passageways of the heater be kept clean and free of obstructions. These areas provide the air necessary for safe operation.



Do not operate the heater if it is not operating properly in any fashion or if you are uncertain. Call your dealer for a full explanation of your heater and what to expect.



Do not store or use gasoline or other flammable liquids in the vicinity of this heater.



Do not operate if any portion of the heater was submerged in water or if any corrosion occurs. Immediately call a qualified service technician to inspect the appliance and to replace any part of the control system and any gas control that has been under water.



Do not place clothing or other flammable items on or near the heater. Because this heater can be controlled by a thermostat there is a possibility of the heater turning on and igniting any items placed on or near it.

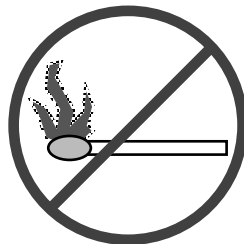

Light the heater using the built-in igniter. Do not use matches or any other external device to light your heater.

Allow the heater to cool before carrying out any maintenance or cleaning.



The viewing glass should be opened only for conducting service. Do not operate with cracked, broken, or removed glass.

Any safety screen or guard removed for servicing must be replaced prior to operating the heater.

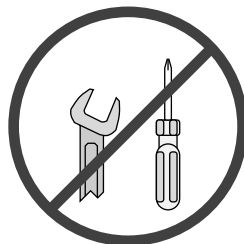

Never remove, replace, modify or substitute any part of the heater unless instructions are given in this manual. All other work must be done by a trained technician. Don't modify or replace orifices.



Operate the heater according to the instructions included in this manual.

If the main burners do not start correctly turn the gas off at the gas control valve and call your dealer for service.

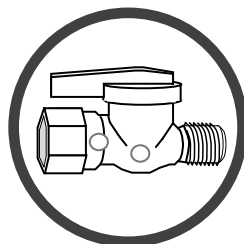

Instruct everyone in the house how to shut gas off to the appliance and at the gas main shutoff valve. The gas main shutoff valve is usually next to the gas meter or propane tank and requires a wrench to shut off.



This unit is not for use with solid fuel

Do not place anything inside the firebox (except the crushed glass).

If any component becomes damaged, replace with Travis Industries components.



Do not throw this manual away. This manual has important operating and maintenance instructions that you will need at a later time. Always follow the instructions in this manual.



Children and adults should be alerted to the hazards of high surface temperature and should stay away to avoid burns or clothing ignition. Young children should be supervised when they are in the same room as the heater.



Travis Industries, Inc. grants no warranty, implied or stated, for the installation or maintenance of your heater, and assumes no responsibility of any consequential damage(s).

Before You Begin

- Read this entire manual before you use your new fireplace (especially the section "Safety Precautions" on pages 4 & 5). Failure to follow the instructions may result in property damage, bodily injury, or even death.

Location of Controls

There is a door on the lower portion of the screen assembly to provide access to the manual controls on the fireplace. The door is held closed by two magnets. Open the door by gently pulling outward on the upper portion of the lower trim.

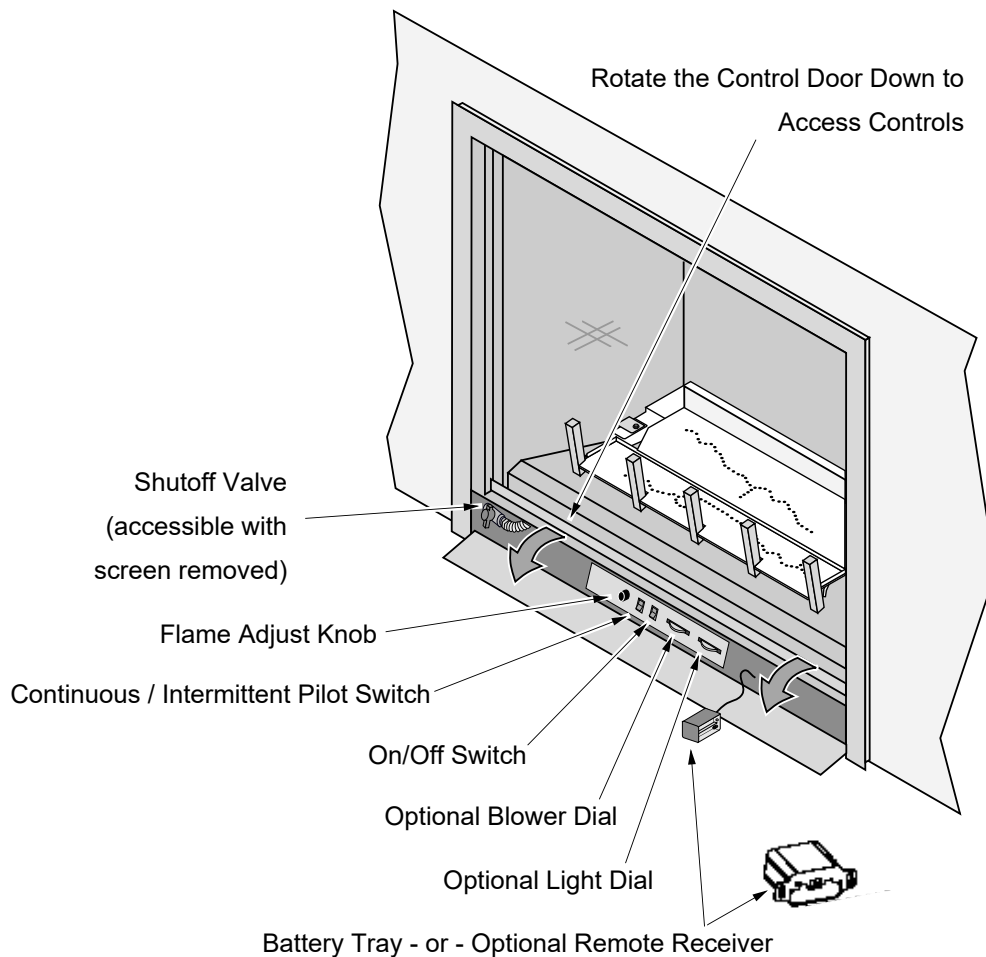

On/Off Switch

This control is used to turn the heater on and off.

Gas Control Knob

This knob is used to control gas to the heater and for starting the pilot. There are three positions, ON, OFF, & PILOT. The pointer to the left of the knob indicates the position this knob is in.

Flame Adjust Knob

This knob controls the flame height from low ("LO") to high ("HI"). The pointer above the knob points to the position this knob is in.

Continuous Pilot -- GreenSmart Pilot

This switch controls how the pilot flame works. See the section "Continuous Pilot / GreenSmart Pilot" for details.

Optional Remote Receiver

The receiver is used in conjunction with the optional remote thermostat. It is used to control the remote and replaces the on/off switch for direct operation.

Optional Blower Dial

This knob controls the speed of the internal convection blower that pushes the heated air into the room.

Optional Light Dial

This dial controls the brightness of the optional accent lights (if applicable).

Starting the Fireplace for the First Time

- Burn the heater at a high setting with the blower off for an extended period (up to 48 hours). This will cure the painted surfaces. **Fumes** from the paint curing and oil burning off the steel will occur. This is normal. We recommend opening a window to vent the room.
- **Condensation** may appear on the glass each time you start the fireplace - this is normal.
- **Blue Flames** will occur on the fireplace when it first comes on. After fifteen minutes the flames will turn a more realistic yellow and orange color.
- Certain installations use a remote, thermostat, or wall switch to turn the fireplace on and off. If this is the case, leave the ON/OFF switch "ON".
- Verify the power backup and control light batteries are installed.

Turning the Fireplace On and Off



ON/OFF SWITCH

Use this switch to turn the main burner on and off manually.

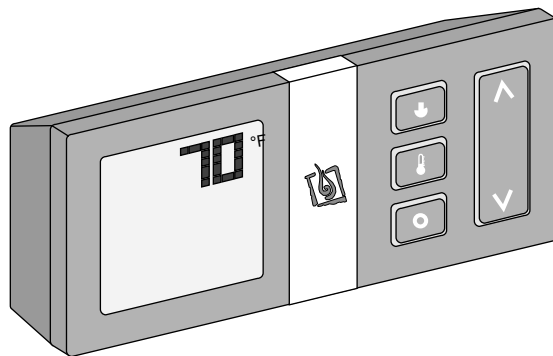

OPTIONAL REMOTE THERMOSTAT

See the instructions included with the remote for details on operation.

- Do not place any combustible items on top of or directly in front of the heater, even temporarily. The optional thermostat may start the heater causing a combustible item to ignite.
- If the heater turns on and off frequently while using the thermostat, you may want to adjust the flame height down until it produces just enough heat needed.

Adjusting the Flame Height

This fireplace has an adjustable flame to tailor the look and heat output to your specific needs. It is adjusted by turning the flame adjust knob.

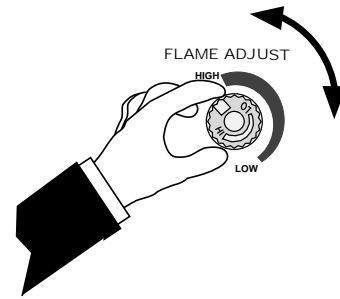

Adjusting the Blower Speed (Optional)

The optional blower helps transfer heat from the heater into the room. It will not turn on until the heater is up to temperature (approximately 10 minutes after starting). See the illustration to the right for instructions on adjusting the blower speed.

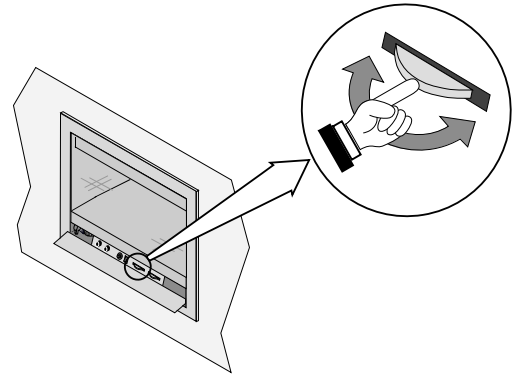

Continuous Pilot / GreenSmart™ Pilot Switch

This fireplace may run with the pilot continuously running or in GreenSmart (intermittent) mode. For most homeowners, the GreenSmart mode is preferred (this saves fuel, doesn't give off un-needed heat). However, in some situations the homeowner may prefer to switch the fireplace to continuous pilot. The most typical reasons for switching to continuous pilot are:

- **Very Cold Conditions** – in very cold conditions you may notice that the burner does not light quickly, and the flames lift off the burner. If this is situation, we recommend you switch to continuous pilot. This will create a slight draft in the vent, allowing for the burner to light quickly and draft correctly.
- **Excessive Condensation on Glass after Startup** – certain installations may encounter excessive fogging on the window after startup (not just the first time the fireplace was started). This is an aesthetic condition that may be remedied by switching the fireplace to continuous pilot.
- **Cold Glass or Fireplace Front** – in very cold conditions you may notice that the fireplace front and glass become very cold. To remedy this, switch the fireplace to continuous pilot.
- **Frequent On / Off Operation** – if you are frequently turning the fireplace on and off, you may wish to leave it in continuous pilot. This allows the burner to turn on more quickly, without pilot ignition delay.

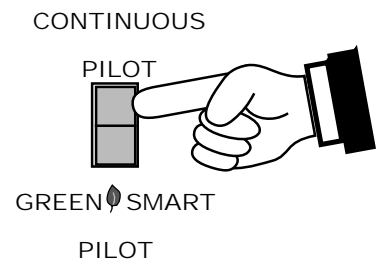

Pilot Fuel Conservation Timer

7 Day Pilot Shutoff Timer (applies to units in CPI mode only)

This appliance may be equipped with a 7 day pilot shutoff timer. This timer helps conserve fuel and save money by turning the pilot off when the appliance is not used for 7 days (this timer is mandated in certain areas for conservation purposes). This applies only when the unit is in CPI (Continuous Pilot Ignition) mode. If the unit is in IPI (Intermittent Pilot Ignition) mode, the timer does not apply.

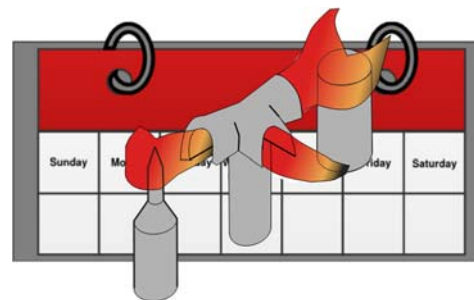

When in CPI mode the pilot will remain lit as long as the burner is engaged within a 7 day window. Each time the burner is turned on the 7 day timer resets. If the burner is not engaged within the 7 day window, the pilot will automatically revert to IPI mode and turn off to conserve fuel.

To switch back to CPI, simply:

GSB2 Units: toggle the IPI/CPI switch to IPI, then back to CPI.

GSR2 Units: use the remote to toggle from IPI mode, then back to CPI mode.

To prevent the need to reset the pilot mode during the heating season, we have listed a few strategies below:

Option 1: Remember to periodically turn on the heater during the heating season

If you use your heater for supplemental heat, this may be the best solution. Set a specific time, once or twice per week (e.g. 5pm on Tuesday & Friday) to turn the heater on for a few minutes. This will reset the timer and prevent the need to restart the pilot.

Option 2: Use a thermostat

GSR Units: Use the thermostat included with the appliance

GSB Units: Consult your dealer for thermostats compatible with your appliance.

The use of a thermostat will keep the room at a constant temperature and will, in most cases, keep the heater working throughout the heating season. Light the pilot at the beginning of the heating season and set the thermostat to the desired room temperature. As long as the outside temperature does not rise excessively, for seven days or more, the pilot will continue to operate.

Option 3: Use a programmable thermostat (GSB2 Only)

A programmable thermostat may be set to turn on, once per week, to a high temperature for a short time. This will reset the 7-day timer and allow the heater to operate without having to restart the pilot.

Adjusting the Blower Speed (Optional)

The optional blower helps transfer heat from the heater into the room. It will not turn on until the heater is up to temperature (approximately 10 minutes after starting). See page 8 for details on adjusting the blower speed.

Normal Operating Odors

This appliance has several areas that reach high temperatures. Dust or other particles on these areas may burn and create an odor. This is normal during start-up. You may notice the smell is more acute if the appliance was left idle for a long period.

Power Outages

Four AA batteries are used as a power backup for the fireplace in case the household (AC) power goes out. These batteries must be inserted into battery holder (or remove receiver is using the optional GS thermostatic remote). The fireplace controller will beep once these batteries start to go dead. Replace batteries before each heating season to insure proper operation.

Glass Frame Removal and Installation



A barrier designed to reduce the risk of burns from the hot viewing glass is provided with this appliance and shall be installed for the protection of children and other at-risk individuals.



If the barrier becomes damaged, the barrier shall be replaced with the manufacturer's barrier for this appliance.



The appliance must be completely cool before removing the glass.



Do not strike or slam the glass.



Warning: Do not operate appliance with the glass front removed, cracked or broken. Replacement of the glass should be done by a licensed or qualified service person.

- Remove the screen-trim assembly by lifting the assembly up slightly and tilting it toward you. The mounting hooks on the back of the assembly will disengage the fireplace. Set the assembly aside for reinstallation.

NOTE: Opening the access door on the front of the assembly allows for an easy location to get a secure grip on the assembly for removal

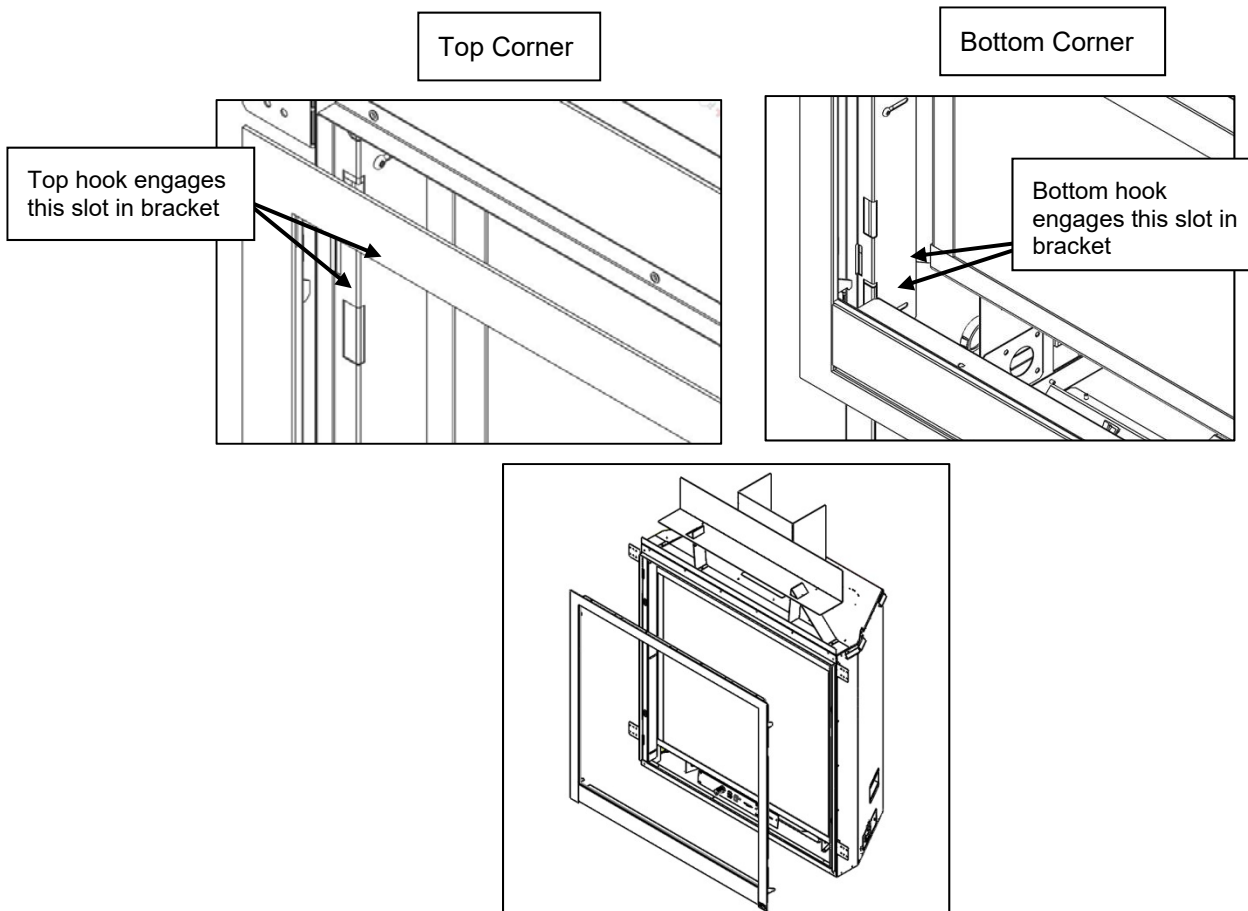

	Replacement Barrier Part #
36 CF ProBuilder	270-01022
42 CF ProBuilder	270-01024

- Remove the glass frame following the directions below.

a Open the latches holding the glass frame in place (start with the bottom) - follow the directions shown to the right.

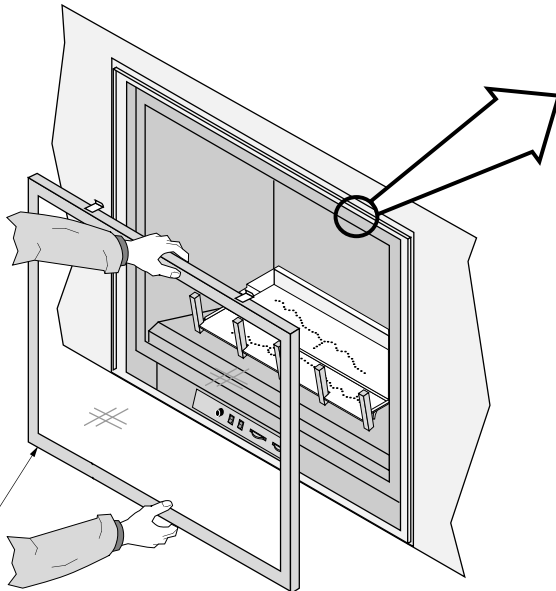

b Lift the glass frame up and pull it forward to remove.

NOTE:
You may need to lift the glass frame while re-attaching.

Re-Attaching the Glass Frame:

- Hang the glass frame on the firebox.
- While holding in place, attach the upper latches (follow the instructions to the right in reverse).
- Lift the glass frame slightly and attach the lower latches.

NOTE: Make sure the glass frame is all the way in place - it should be parallel with the front of the fireplace when installed.

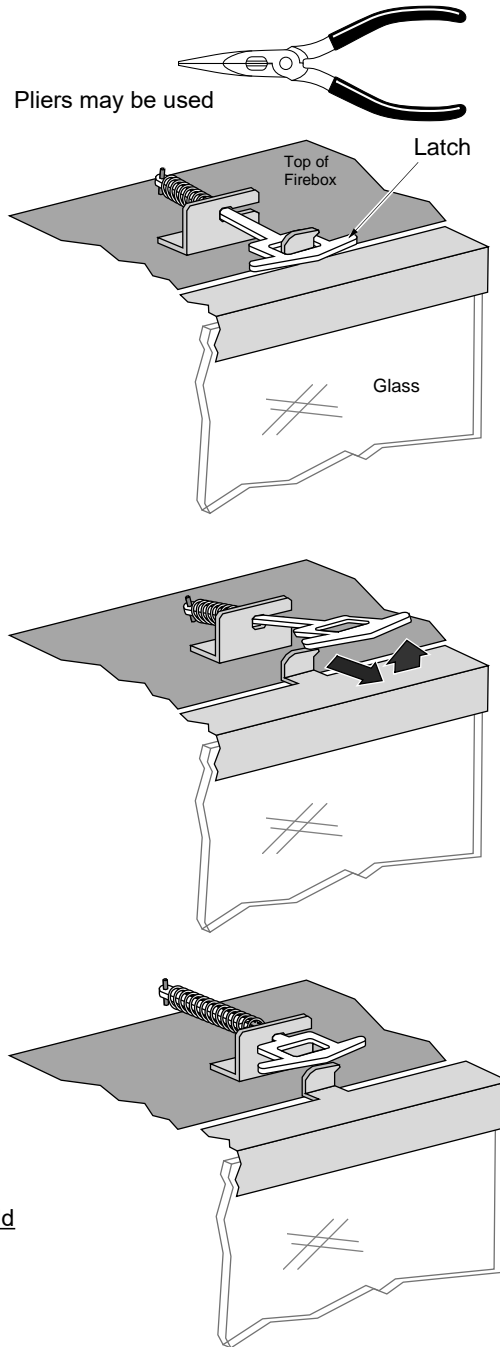

Replacement Glass Frame Part #	
36 CF ProBuilder	270-01009
42 CF ProBuilder	270-01025

The latch can come loose from glass frame anchor. This occurs when it is turned 1/4 turn when it is disengaged. Follow the directions below to re-install the latch if it becomes loose.

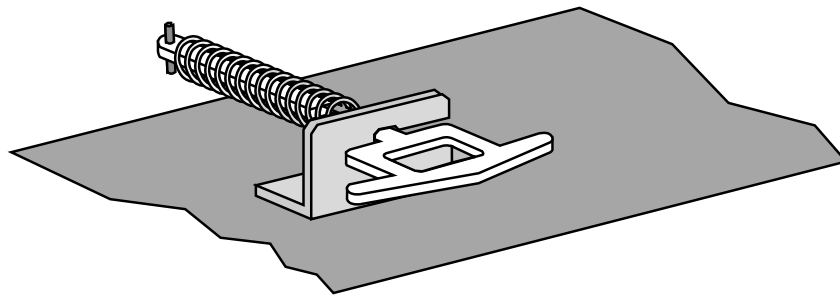
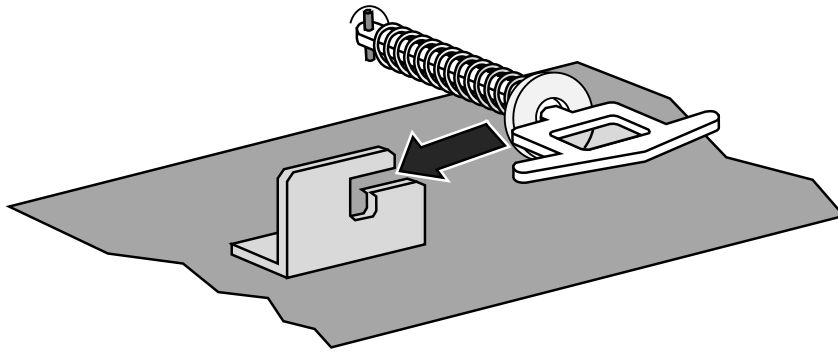

PB 36 Log Set Installation

Installation Warnings

NOTE: Consult the installation manual for order of installation. If using propane (LP), convert the appliance before installing the log set. If using firebacks, install them prior to installing the log set.

- **The logs are fragile, especially after being exposed to heat.**
- Make sure the gas control valve is OFF and the heater is cool prior to installing logs.
- Failure to position the parts in accordance with these diagrams or failure to use only parts specifically approved with this appliance may result in property damage or personal injury.
- The burner must be correctly positioned before installing the log set. Make sure the burner is fully seated and the pilot is properly aligned. See owner's manual for details on burner removal.

Log Set Overview

When installed, the (8) logs should appear as shown below. The directions on the following pages detail installation of this log set.

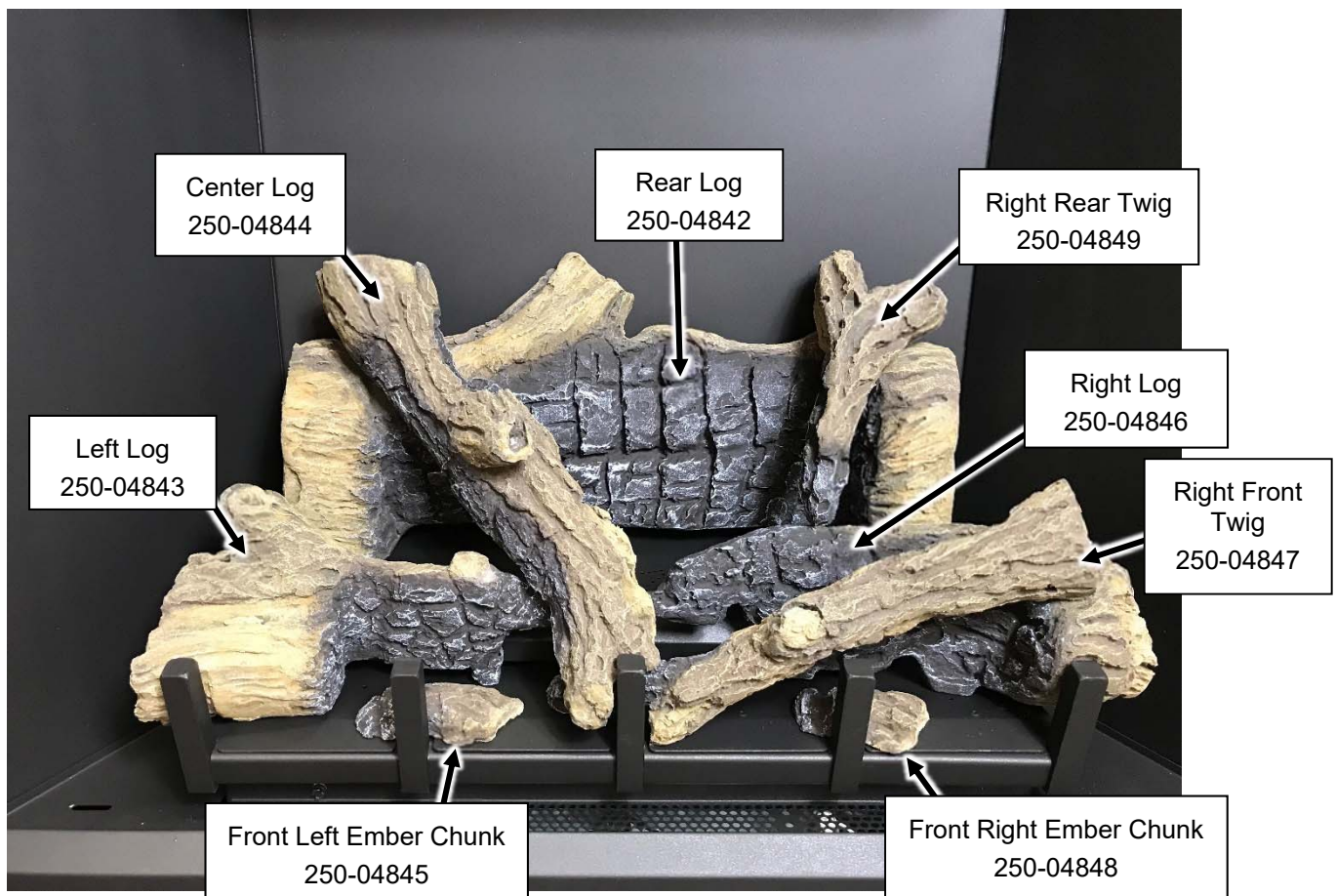

Rear Log

The rear log has two pockets that insert over two tabs on the back burner (see photos below). Place the log in place and push it back. The log straddles the burner and does not cover any burner holes. Make sure the corner of the log is lined up with the rivet on the burner as shown in the lower right picture.



Left Log

The left log has a channel (A) on the bottom that fits over a ridge on the burner and a notch (B) that contacts the grate. Set the log in place and slide it to the rear.

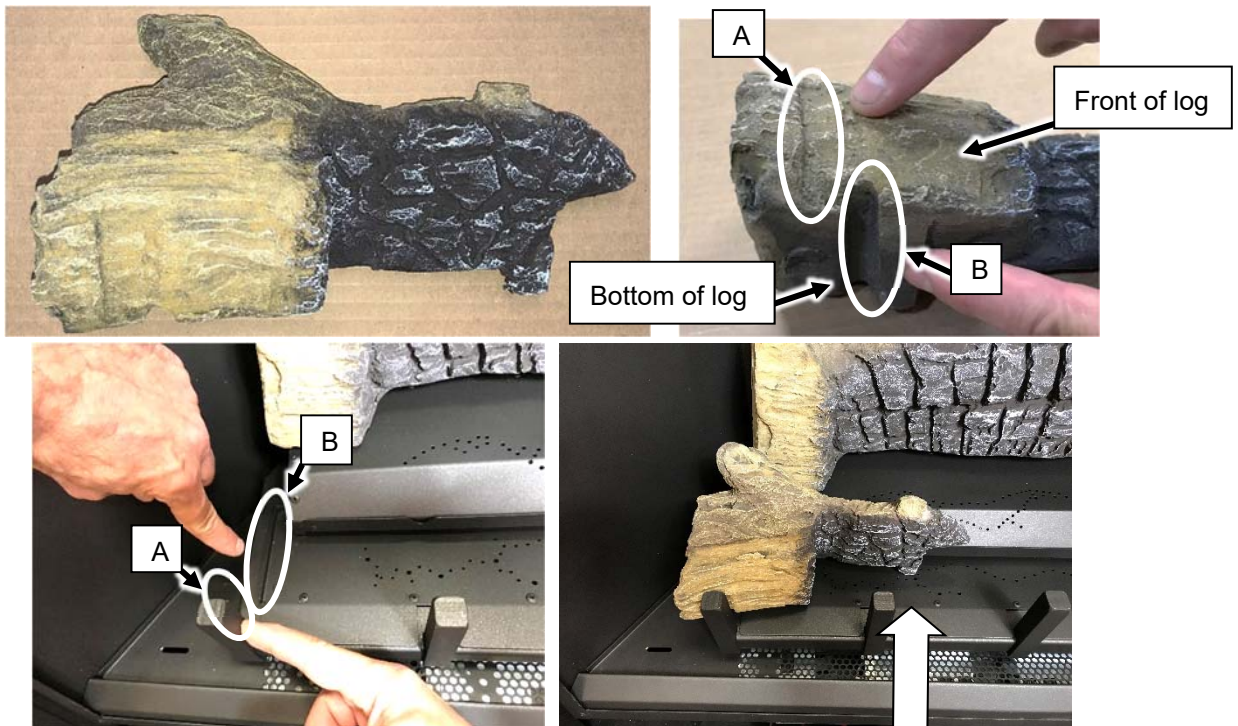

Right Log

The right log has a channel (C) on the bottom that fits over a ridge on the burner and a notch (D) that contacts the grate.

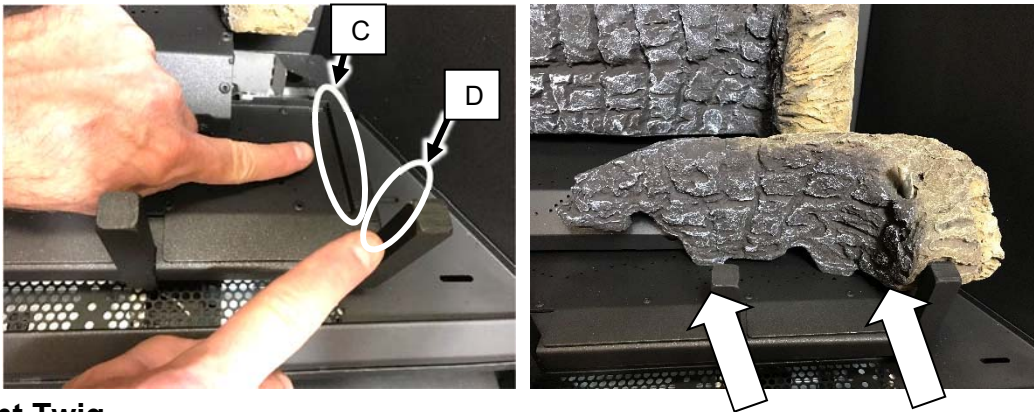

Right Front Twig

The right front twig has a hole for a locating pin on the bottom and a notch to rest on the grate at one end. Place twig over the pin and adjust so the notch is in contact with the grate as shown below.



Right Rear Twig

The right rear twig is shown below. It has a hole for a locating pin on the bottom. When in place, the front tip just barely rests on the right log as shown below.



Center Log

The center log has a hole for a locating pin on the bottom and a notch to rest on the grate at one end.



Ember Chunk Identification

There are (2) ember chunks, that look very similar, included with this log set. It is important that they are on the correct side of the burner or they may cause flame impingement. Blower is a picture that shows the ember chunks side by side to aid with identification.



Left Ember Chunk

The left ember chunk has a flat bottom and charred end. The chunk fits behind the bar, 2nd from the left, of the log grate. The charred end should be to the left. Place the ember chunk as shown below. Make sure the chunk is positioned so it does not cover any burner holes.

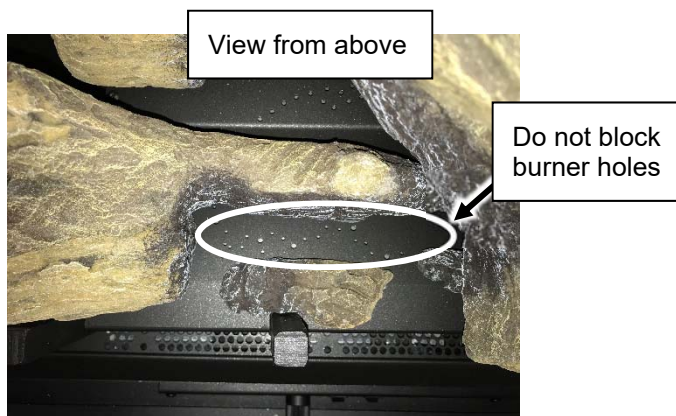

Right Ember Chunk

The right ember chunk also has a charred end. The chunk fits behind the bar, 2nd from the right, of the log grate. The charred end should also be to the left as shown below.



PB 42 Log Set Installation

Installation Warnings

NOTE: Consult the installation manual for order of installation. If using propane (LP), convert the appliance before installing the log set. If using firebacks, install them prior to installing the log set.

- The logs are fragile, especially after being exposed to heat.
- Make sure the gas control valve is OFF and the heater is cool prior to installing logs.
- Failure to position the parts in accordance with these diagrams or failure to use only parts specifically approved with this appliance may result in property damage or personal injury.
- The burner must be correctly positioned before installing the log set. Make sure the burner is fully seated and the pilot is properly aligned. See owner's manual for details on burner removal.

Log Set Overview

When installed, the (8) logs should appear as shown below. The directions on the following pages detail installation of this log set.

Log Name	Rear Log	Left Log	Right Log	Left Twig	Right Front Twig	Right Rear Twig	Left Ember Chunk	Right Ember Chunk
Replacement Part Number	250-05070	250-05071	250-05072	250-05073	250-05074	250-05075	250-05076	250-05077
Number on Back of Log	1	2	3	4	5	6	7	8

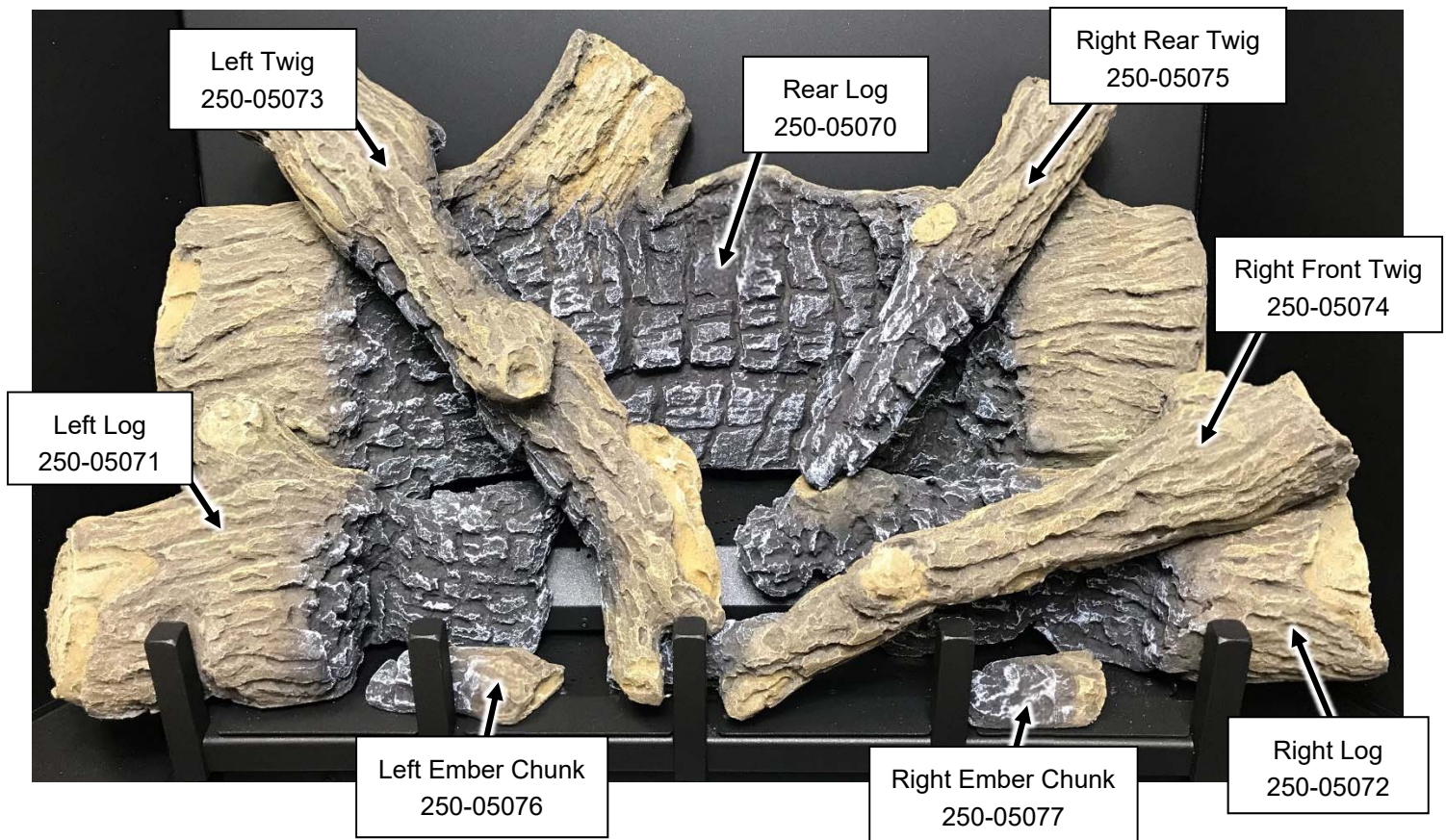

Rear Log

The back log has two pockets that insert over two tabs on the back burner (see photos below). Place the log in place and push it back. The log straddles the burner and does not cover any burner holes.

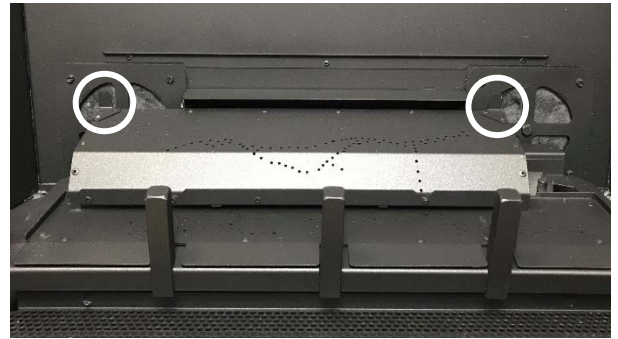

Left Log

The left log has a channel (A) on the bottom that fits over a ridge on the burner and a notch (B) that contacts the grate. Set the log in place and slide it to the rear.

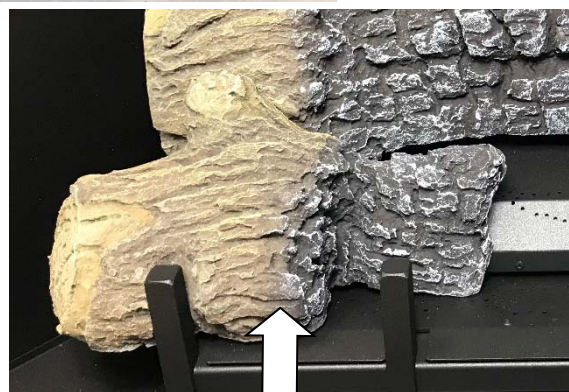
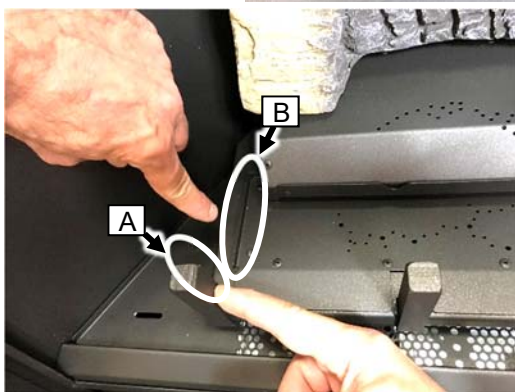
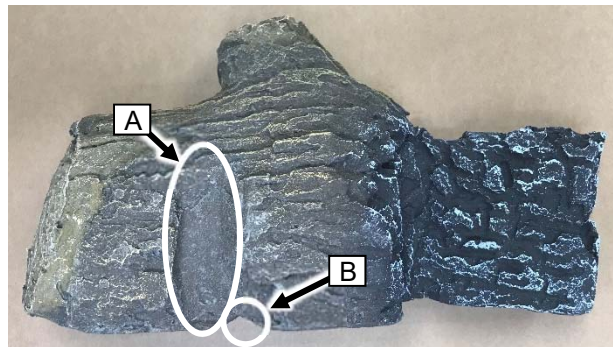

Right Log

The right log has a channel on the bottom that fits over a ridge on the burner. Push the log backwards as far as it will go.

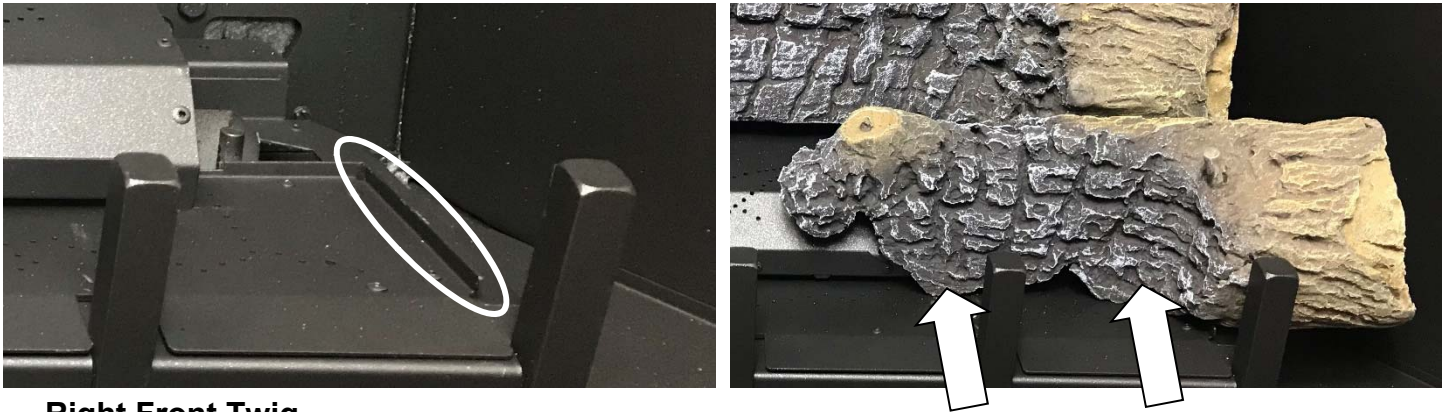

Right Front Twig

The right front twig has a hole for a locating pin on the bottom and a notch to rest on the grate at one end. Place twig over the pin and adjust so the notch is in contact with the grate as shown below.



Right Rear Twig

The right rear twig is shown below. It has a hole for a locating pin on the bottom. When in place, the front tip just barely rests on the right log as shown below.



Center Log

The center log has a hole for a locating pin on the bottom and a notch to rest on the grate at one end.



Ember Chunk Identification

There are (2) ember chunks, that look very similar, included with this log set. It is important that they are on the correct side of the burner or they may cause flame impingement. Below is a picture that shows the ember chunks side by side to aid with identification.

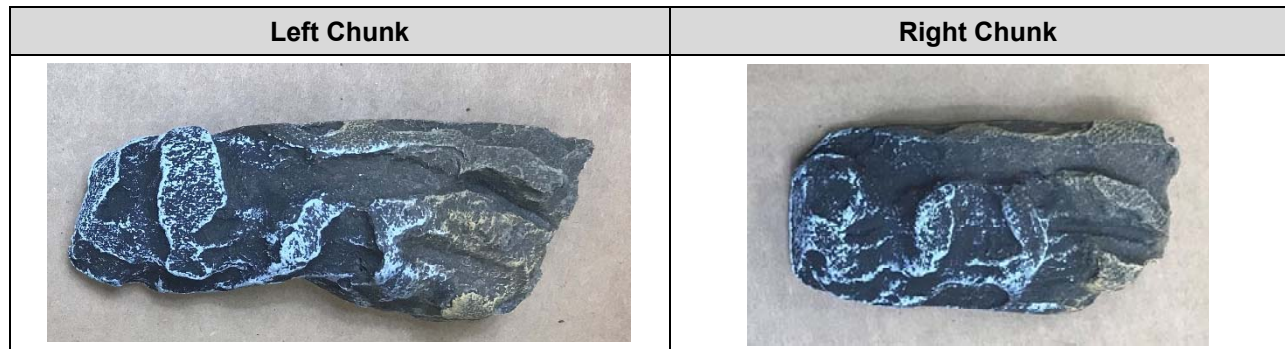

Left Ember Chunk

The left ember chunk has a flat bottom and charred end. The chunk fits behind the bar, 2nd from the left, of the log grate. The charred end should be to the left. Place the ember chunk as shown below. Make sure the chunk is positioned so it does not cover any burner holes.

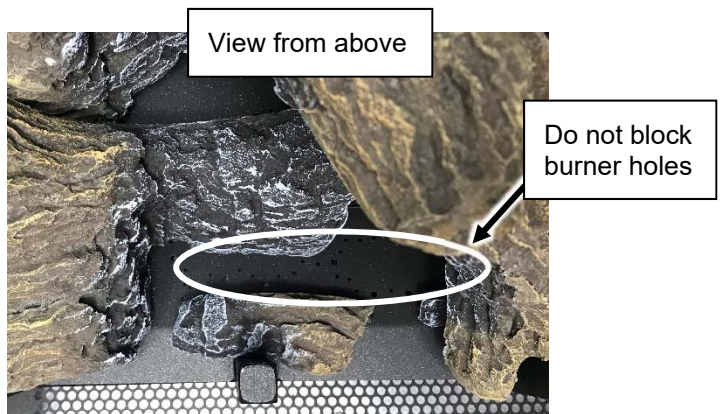

Right Ember Chunk

The right ember chunk also has a charred end. The chunk fits behind the bar, 2nd from the right, of the log grate. The charred end should also be to the left as shown below.

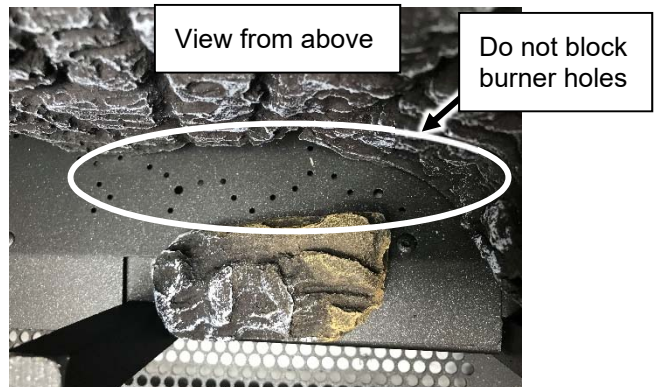

Ember Installation

A bag of embers is provided to further enhance the firebox. Place the embers on the firebox floor and on the burner. Do not place embers over any of the burner holes or air channels.



Rock Wool Placement

The included rock wool is placed on top of the burner to enhance the glow from the burner. **The rock wool works best when it is applied in a very thin layer.** The best method for applying the rock wool is to brush it on to the burner. Compress a clump of rockwool between your thumb and forefinger. Use a stiff brush to apply a thin layer of rockwool fibers onto the burner. Do not use the entire bag of rockwool. Use only a small amount and save the remainder. Over-use of rockwool will diminish the glow and may cause sooting or other adverse conditions.

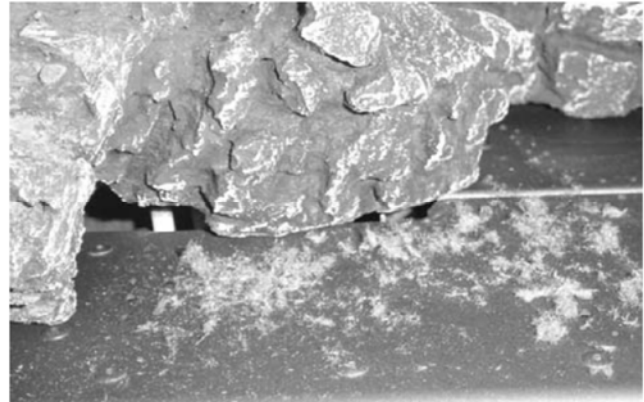

Maintaining Your Heater's Appearance



The appliance must be completely cool prior to conducting service.

Cleaning The Glass

The glass may be cleaned with a non-abrasive cleaner. To clean the inside of the glass, simply remove the glass frame, place it on a non-scratching surface, and clean the surface.

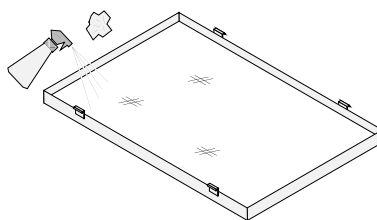

Cleaning the Fireplace

Use a duster to remove dust from the visible portions of the fireplace. Contact your dealer if you wish to re-paint any surfaces. Heat-resistant stove-paint (with instructions) is available from your dealer.

Yearly Service Procedure

WARNING: Failure to inspect and maintain the stove may lead to improper combustion and a potentially dangerous situation. We recommend the following procedures be done by a qualified technician.

- Shut off gas to the fireplace and let it cool for 15 minutes. Remove the glass. Inspect and operate the pressure relief mechanism to verify relief mechanisms are free from obstruction to operate.
- Clean glass window with a suitable fireplace glass cleaner. Abrasive cleaners must not be used. Be careful not to scratch the glass when cleaning.
- Vacuum and clean any debris in the firebox.
- Check all accessible gas-carrying tubes, connections, pipes and other components for leaks.
- Inspect the burner and firebox. Make sure the burner is not warped, cracked, or damaged. Check the firebox and area around the pilot to make sure there is no damage. Inspect primary air openings for blockage. If any problem is found, discontinue use and contact your dealer for service.
- Inspect the area behind the access door; clean if necessary. Check the gas control valve and the gas lines. If damage is found, discontinue use and contact your dealer for service. Clean the air channels, ducts, and blower (if applicable)
- Inspect vent and vent termination for sooting, obstructions, or damage. Make repairs as needed. Remove any debris or vegetation near the vent termination. Contact your dealer if any sooting or deterioration is found near the vent termination.
- Reinstall the glass assembly. If the glass is damaged, replace. Make sure the gasket along the perimeter of the glass contacts the face of the firebox and forms an air-tight seal. If it does not, re-align or replace the gasket to insure an air-tight seal.
- Turn the pilot flame on (continuous pilot). It should touch approximately 3/8" of the top of the flame sensor (see below). If it does not, contact your dealer.

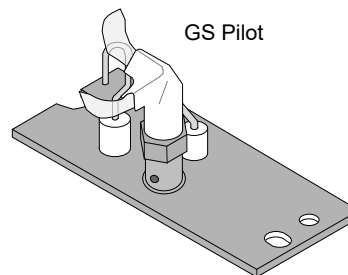

- Start the main burner. Inspect and ensure the lighting of the main burner occurs within 4 seconds of the main gas valve opening.
- Test the flame failure response time of the flame safety system. It must de-energize the safety shutoff in no more than 30 seconds.
- After 15 minutes the flames should be orange/yellow and not touch the top of the firebox. If the pilot or main burners do not burn correctly, contact your dealer for service. Monitor blower operation

Troubleshooting Table

Problem:	Possible Cause:	Don't Call for Service Until You:
Pilot Will Not Light	A gas shut off valve is turned off..... The gas control knob isn't turned to "PILOT"..... The valve control knob isn't pushed in..... The igniter wasn't pressed repeatedly..... No Propane in Tank.....	Check all gas shut off valves See "Starting the Pilot Light" Step C See "Starting the Pilot Light" Step C See "Starting the Pilot Light" Step C Check Tank Level
Main Burners Will Not Start	The pilot light has gone out..... The gas control valve is turned to "PILOT" or "OFF" The ON/OFF switch is turned to "OFF"..... The remote control is not working correctly..... The thermostat is disconnected or set too low.....	See "Starting the Pilot Light" See "Starting the Pilot Light" Turn the ON/OFF switch to "ON" See the remote control instructions See "Thermostat Operation"
Optional Remote Control Does Not Work	The pilot light has gone out..... The gas control valve is turned to "PILOT" or "OFF" The ON/OFF switch is turned to "OFF"..... The remote is too far away from the heater..... The remote control receiver is turned "Off"..... Remote or receiver batteries are dead.....	See "Starting the Pilot Light" See "Starting the Pilot Light" Turn the ON/OFF switch to "ON" Use the remote closer to the heater See the remote control instructions See the remote control instructions
Heater Will Not Distribute Heat	The heater is not up to temperature.....	This is normal – allow 5 to 20 minutes for heater to reach operating temperature.
Optional Blower Does Not Turn On	The heater is not up to temperature..... The heater is not getting electricity..... The blower is set to off.....	The blower will turn on once the heater is up to temperature (5 to 20 minutes). Check the breaker switch. Check the blower knob.
Pilot Goes Out Intermittently	The gas supply has been shut off.....	Keep the gas supply turned on
Flames Are Too Blue	The heater has just been started..... Improper air shutter adjustment.....	This is normal - see "Starting the Heater for the First Time" Adjust Air Shutter - contact your dealer
Flames Are Too Short (Under 6")	The flame height may be turned too low.....	Turn the flame height to "HI" - See "Adjusting the Flame Height"
Thin Layer of Soot Covers the Glass	The logs or coals are placed incorrectly..... Improper air shutter adjustment.....	See "Log Set Installation" Adjust Air Shutter - contact your dealer

Replacement Parts List

Caution: Use only Travis Industries replacement parts. Do not use substitute materials.

Warning: Do not operate appliance with the glass front removed, cracked, or broken. Replacement of the glass should be done by a licensed or qualified service person.

36PB Part Numbers

GLASS w/FRAME	270-01009
SCREEN BARRIER, FRONT	270-01008
PILOT ASS'Y, 2-WAY PSE	250-04480
VALVE, NG w/MANUAL H/L	250-04398
VALVE REGULATOR, LP MAN HI-LO	250-01427

42PB Part Numbers

<u>GLASS w/FRAME</u>	<u>270-01025</u>
<u>SCREEN BARRIER, FRONT</u>	<u>270-01024</u>
<u>PILOT ASS'Y, 2-WAY PSE</u>	<u>250-04480</u>
<u>VALVE, NG w/MANUAL H/L</u>	<u>250-04398</u>
<u>VALVE REGULATOR, LP MAN HI-LO</u>	<u>250-01427</u>

Contact your local Travis Industries Dealer to purchase replacement parts

Wiring Diagram

Caution: Label all wires prior to disconnection when servicing controls. Wiring errors can cause improper and dangerous operation.

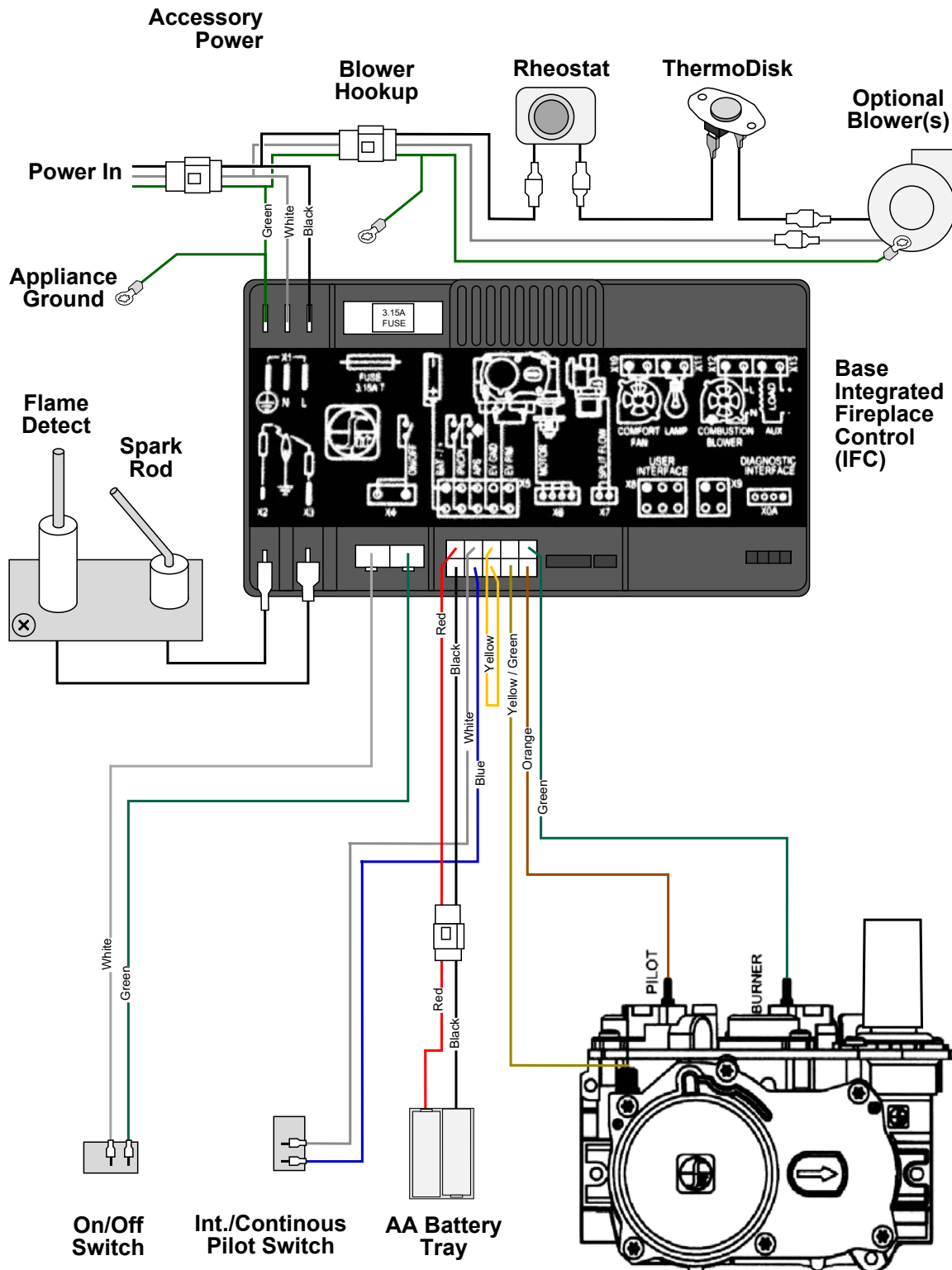

36 CF Safety Label

The safety (listing) label is attached to the operating tag (chained to the heater near the gas control valve). A copy is shown below

<p>Minimum Clearances to Combustibles</p>	
Fireplace to Adjacent Wall	0" (0mm)
Wood Floor Beneath Fireplace	0" (0mm)
Back To Enclosure	0.5" (13mm)
Base Of Fireplace To Enclosure Top	61.875" (1572mm)
Sides To Enclosure	0.5" (13mm)
Base Of Fireplace To A Mantel	See Owner's Manual

<p>FAN TYPE VENTED CIRCULATOR (OPTIONAL)</p>	
<p>Blower Electrical Rating: 120 VAC, 4.5 Amps, 60 Hz, 540 Watts (Part No. 250-04756) fan or blower assembly may be used. For use only with factory barrier (see "Glass Frame Removal" in the installation manual for part numbers). Follow installation instructions.</p>	
L.P.	N.G.
Input Rate on "HI" (BTU/Hr)	24,000 25,000
Input Rate on "LO" (BTU/Hr)	12,000 13,000
Front Orifice Size - (DMS)	#63 #54
Rear Orifice Size - (DMS)	#57 #48
L.P.	N.G.
Minimum Inlet Pressure (inches W.C.)	11" 5.5"
Maximum Inlet Pressure (inches W.C.)	13" 7"
Manifold Pressure on "HI" (inches W.C.)	11" 3.8"

This appliance is equipped for use only at altitudes 0-2,000 feet (0-610m) in the USA. In Canada, 0-4,500 feet (0-1370m). For altitudes above 2,000 feet, the vent configuration, orifice, or combination of both may be need to be changed. See owner's manual for information on making these changes.



ProBuilder 36
CF MV
ProBuilder 36
CF GSB2

Vented Gas Fireplace Heater
Not for use with solid fuel

Tested to: ANSI Z21.88-2016/CSA 2.33-2016 "Vented Gas Fireplace Heater", CGA 2.17-M91 (R2014) "Gas-fired appliances for use at high altitudes", and CSA P.4.1-15 Testing method for measuring annual fireplace efficiency.

This appliance must be installed in accordance with local codes, if any; if none, follow the National Fuel Gas Code, ANSI Z223.1/NFPA 54, or Natural Gas and Propane Installation Codes, CSA B149.1.

This appliance must be installed in accordance with the current Standard CAN/CSA Z240 MH, Mobile Housing, in Canada or with the Manufactured Home Constructions and Safety Standard, Title 24 CFR, Part 3280, in the United States, or when such a standard is not applicable, ANSINC-S-BCS A225.1/NFPA 501A, Manufactured Home Installation Standard.

This vented gas fireplace heater is equipped at the factory for use with natural gas. If conversion to propane (LP) is desired, the optional factory conversion kit must be used. Part No. 250-04755 (GSB2) or 250-04754 (MV) kit may be used.

This appliance is only for use with the type(s) of gas indicated on the rating plate and may be installed in an aftermarket, permanently located, manufactured home (USA only) or mobile home, where not prohibited by local codes. See owner's manual for details. This appliance is not convertible for use with other gases, unless a certified kit is used.

This vented gas fireplace heater is not for use with air filters. Keep burner and control compartment clean. See installation and operating instructions accompanying appliance.

This appliance must be properly connected to a venting system in accordance with the manufacturer's installation instructions. Use only an approved direct vent system to vent this appliance to the exterior. See owner's manual for approved brands of venting.

If the vent-air intake system is disconnected for servicing or any other reason, it must be resealed and / or reinstalled.

WARNING: Improper installation, adjustment, alteration, service or maintenance can cause injury or property damage. Refer to the owner's information manual provided with this appliance. For assistance or additional information consult a qualified installer, service agency or the gas supplier.

Manufactured by:



TRAVIS INDUSTRIES
HOUSE OF FIRE
12521 Harbour Reach Drive
Mukilteo, WA 98275
www.travisproducts.com

MANUFACTURE DATE:

<input type="checkbox"/> 2018	<input type="checkbox"/> Jan.	<input type="checkbox"/> Apr.	<input type="checkbox"/> Jul.	<input type="checkbox"/> Oct.
<input type="checkbox"/> 2019	<input type="checkbox"/> Feb.	<input type="checkbox"/> May	<input type="checkbox"/> Aug.	<input type="checkbox"/> Nov.
<input type="checkbox"/> 2020	<input type="checkbox"/> Mar.	<input type="checkbox"/> Jun.	<input type="checkbox"/> Sep.	<input type="checkbox"/> Dec.

CAUTION: Do not operate this appliance with glass removed, cracked or broken. Replacement of the panel(s) should be done by a licensed or qualified service person. Hot while in operation. Do not Touch. Severe burns may result. Keep children, clothing, furniture, gasoline and other flammable liquids having flammable vapors away.

42 CF Safety Label

The safety (listing) label is attached to the operating tag (chained to the heater near the gas control valve). A copy is shown below

Minimum Clearances to Combustibles

Fireplace to Adjacent Wall	0" (0mm)	Base Of Fireplace To Enclosure Top	68" (1728mm)
Wood Floor Beneath Fireplace	0" (0mm)	Sides To Enclosure	0.5" (13mm)
Back To Enclosure	0.5" (13mm)	Base Of Fireplace To A Mantel	See Owner's Manual

FAN TYPE VENTED CIRCULATOR (OPTIONAL)

Blower Electrical Rating: 120 VAC, 4.5 Amps, 60 Hz, 540 Watts (Part No. 250-04756) fan or blower assembly may be used. For use only with factory barrier (see "Glass Frame Removal" in the installation manual for part numbers). Follow installation instructions.

	PROPANE	N.G.	PROPANE	N.G.
Input Rate on "HI" (BTU/Hr)	35,000	35,000	Minimum Inlet Pressure (inches W.C.)	11" 5.5"
Input Rate on "LO" (BTU/Hr)	17,500	18,000	Maximum Inlet Pressure (inches W.C.)	13" 7"
Front Orifice Size - (DMS)	#58	#50	Manifold Pressure on "HI" (inches W.C.)	11" 3.8"
Rear Orifice Size - (DMS)	#C55	#44		

This appliance is equipped for use only at altitudes 0-2,000 feet (0-610m) in the USA. In Canada, 0-4,500 feet (0-1370m).
For altitudes above 2,000 feet, the vent configuration, orifice, or combination of both may be need to be changed.
See owner's manual for information on making these changes.

MANUFACTURE DATE:

<input type="checkbox"/> 2019	<input type="checkbox"/> Jan.	<input type="checkbox"/> Apr.	<input type="checkbox"/> Jul.	<input type="checkbox"/> Oct.
<input type="checkbox"/> 2020	<input type="checkbox"/> Feb.	<input type="checkbox"/> May	<input type="checkbox"/> Aug.	<input type="checkbox"/> Nov.
<input type="checkbox"/> 2021	<input type="checkbox"/> Mar.	<input type="checkbox"/> Jun.	<input type="checkbox"/> Sep.	<input type="checkbox"/> Dec.

Manufactured by:



TRAVIS INDUSTRIES
HOUSE OF FIRE
12521 Harbour Reach Drive
Mukilteo, WA 98275
www.travisproducts.com

XXXX

CAUTION: Do not operate this appliance with glass removed, cracked or broken. Replacement of the panel(s) should be done by a licensed or qualified service person. Hot while in operation. Do not Touch. Severe burns may result. Keep children, clothing, furniture, gasoline and other flammable liquids having flammable vapors away.

ProBuilder 42
CF MV

ProBuilder 42
CF GSB2

Vented Gas Fireplace Heater
Not for use with solid fuel

Tested to: ANSI Z21.88-2016/CSA 2.33-2016 "Vented Gas Fireplace Heater", CSA 2.17-2017 "Gas-fired appliances for use at high altitudes", and CSA P.4.1-15 Testing method for measuring annual fireplace efficiency.

This appliance must be installed in accordance with local codes, if any; if none, follow the National Fuel Gas Code, ANSI Z223.1/NFPA 54, or Natural Gas and Propane Installation Codes, CSA B149.1.

This appliance must be installed in accordance with the current Standard CAN/CSA Z240 MH, Mobile Housing, in Canada or with the Manufactured Home Construction and Safety Standard, Title 24 CFR, Part 3280, in the United States, or when such a standard is not applicable, ANSI/NCSCS A225.1/NFPA 501A, Manufactured Home Installation Standard.

This vented gas fireplace heater is equipped at the factory for use with natural gas. If conversion to propane (LP) is desired, the optional factory conversion kit must be used. Part No. 250-04755 (GSB2) or 250-04754 (MV) kit may be used.

This appliance is only for use with the type(s) of gas indicated on the rating plate and may be installed in an aftermarket, permanently located, manufactured home (USA only) or mobile home, where not prohibited by local codes. See owner's manual for details. This appliance is not convertible for use with other gases, unless a certified kit is used.

This vented gas fireplace heater is not for use with air filters.

Keep burner and control compartment clean. See installation and operating instructions accompanying appliance.

This appliance must be properly connected to a venting system in accordance with the manufacturer's installation instructions. Use only an approved direct vent system to vent this appliance to the exterior. See owner's manual for approved brands of venting.

If the vent-air intake system is disconnected for servicing or any other reason, it must be resealed and / or reinstalled.

WARNING: Improper installation, adjustment, alteration, service or maintenance can cause injury or property damage. Refer to the owner's information manual provided with this appliance. For assistance or additional information consult a qualified installer, service agency or the gas supplier.

Register your TRAVIS INDUSTRIES, INC. Limited 7 Year Warranty online at traviswarranty.com. TRAVIS INDUSTRIES, INC. warrants this gas appliance (appliance is defined as the equipment manufactured by Travis Industries, Inc.) to be defect-free in material and workmanship to the original purchaser from the date of purchase as follows:

Check with your dealer in advance for any costs to you when arranging a warranty call.
Mileage or service charges are not covered by this warranty. This charge can vary from store to store.

Component	Years 1 & 2 Parts & Labor	Years 3 Through 5 Parts & Labor	Years 6 & 7 Parts Only
Burner Assembly Burner Pan Assembly, Air Shutter Assembly, Main Burner Orifice	✓		
Electrical Assembly (within heater structure): Wiring harness, snap discs, rheostat speed control	✓		
Gas Control Assembly Adjustable control valve, fireplace controller, pilot assembly and pilot wiring	✓		
Glass Glass (breakage from thermal shock)	✓		
Gold, Nickel & Copper Plating Face & Door (see "Conditions and Exclusions" # 9)	✓		
Accessories Firebacks, Power Heat Ducts, Andirons, etc...	✓		
One-Way Freight Allowance One-way freight allowance on pre-authorized repair done at factory is covered.	✓	✓	
Convection Heat Exchanger Convection heat exchanger assembly	✓	✓	
Firebox Assembly Adjustable Air Restrictor, Pressure Relief Mechanisms, Glass Attachment Mechanism	✓	✓	✓

EXCLUDED COMPONENTS:

Paint, Gasketing, and Accent Light Bulbs

CONDITIONS & EXCLUSIONS

- This new gas appliance must be installed by a qualified gas appliance technician. It must be installed, operated, and maintained at all times in accordance with the instructions in the Owner's Manual. Any alteration, willful abuse, accident, neglect, or misuse of the product shall nullify this warranty.
- This warranty is nontransferable, and is made to the ORIGINAL purchaser, provided that the purchase was made through an authorized TRAVIS dealer.
- Discoloration and some minor expansion, contraction, or movement of certain parts and resulting noise, is normal and not a defect and, therefore, not covered under warranty. The installer must ensure the appliance is burning as per the rating tag at the time of installation. Over-firing (operation above the listed BTU rate) of this appliance can cause serious damage and will nullify this warranty.
- The warranty, as outlined within this document, does not apply to the chimney components or other Non-Travis accessories used in conjunction with the installation of this product. If in doubt as to the extent of this warranty, contact your authorized TRAVIS retailer before installation.
- Travis Industries will not be responsible for inadequate performance caused by environmental conditions such as nearby trees, buildings, roof tops, wind, hills or mountains or negative pressure or other influences from mechanical systems such as furnaces, fans, clothes dryers, etc.
- This Warranty is void if:
 - The unit has been operated in atmospheres contaminated by chlorine, fluorine or other damaging chemicals.
 - The unit is subject to submersion in water or prolonged periods of dampness or condensation.
 - Any damage to the unit, combustion chamber, heat exchanger or other components due to water, or weather damage which is the result of, but not limited to, improper chimney/venting installation.
- Exclusions to this 7 Year Warranty include: injury, loss of use, damage, failure to function due to accident, negligence, misuse, improper installation, alteration or adjustment of the manufacturer's settings of components, lack of proper and regular maintenance, damage incurred while the appliance is in transit, alteration, or act of God.
- This 7 Year warranty excludes damage caused by normal wear and tear, such as paint discoloration or chipping, worn or torn gasketing, corroded or cracked logs, embers, etc. Also excluded is damage to the unit caused by abuse, improper installation, modification of the unit, drilling of the orifices, or the use of fuel other than that for which the unit is configured. Units are shipped for natural gas and must be converted to propane using the included conversion kit. Confirm fuel configuration with your installer.
- Damage to gold or nickel surfaces caused by fingerprints, scratches, melted items, or other external sources left on the gold or nickel from the use of cleaners other than denatured alcohol is not covered in this warranty.
- TRAVIS INDUSTRIES, INC. is free of liability for any damages caused by the appliance, as well as inconvenience expenses and materials. Incidental or consequential damages are not covered by this warranty. In some states, the exclusion of incidental or consequential damage may not apply.
- This warranty does not cover any loss or damage incurred by the use or removal of any component or apparatus to or from the gas appliance without the express written permission of TRAVIS INDUSTRIES, INC. and bearing a TRAVIS INDUSTRIES, INC. label of approval.
- Any statement or representation of TRAVIS products and their performance contained in TRAVIS advertising, packaging literature, or printed material is not part of this 7 year warranty.
- This warranty is automatically voided if the appliance's serial number has been removed or altered in any way. If the appliance is used for commercial purposes, it is excluded from this warranty.
- No dealer, distributor, or similar person has the authority to represent or warrant TRAVIS products beyond the terms contained within this warranty. TRAVIS INDUSTRIES, INC. assumes no liability for such warranties or representations.
- Travis Industries will not cover the cost of the removal or re-installation of hearths, facing, mantels, venting or other components.
- If for any reason any section of this warranty is declared invalid, the balance of the warranty remains in effect and all other clauses shall remain in effect.
- THIS 7 YEAR WARRANTY IS THE ONLY WARRANTY SUPPLIED BY TRAVIS INDUSTRIES, INC., THE MANUFACTURER OF THE APPLIANCE. ALL OTHER WARRANTIES, WHETHER EXPRESS OR IMPLIED, ARE HEREBY EXPRESSLY DISCLAIMED AND PURCHASER'S RECOURSE IS EXPRESSLY LIMITED TO THE WARRANTIES SET FORTH HEREIN.**

IF WARRANTY SERVICE IS NEEDED:

- If you discover a problem that you believe is covered by this warranty, you MUST REPORT it to your TRAVIS dealer WITHIN 30 DAYS, giving them proof of purchase, the purchase date, and the model name and serial number.
- Travis Industries has the option of either repairing or replacing the defective component.
- If your dealer is unable to repair your appliance's defect, he may process a warranty claim through TRAVIS INDUSTRIES, INC., including the name of the dealership where you purchased the appliance, a copy of your receipt showing the date of the appliance's purchase, and the serial number on your appliance. At that time, you may be asked to ship your appliance, freight charges prepaid, to TRAVIS INDUSTRIES, INC. TRAVIS INDUSTRIES, INC., at its option, will repair or replace, free of charge, your TRAVIS appliance if it is found to be defective in material or workmanship within the time frame stated within this 7 year warranty. TRAVIS INDUSTRIES, INC. will return your appliance, freight charges (years 1 to 5) prepaid by TRAVIS INDUSTRIES, INC., to your regional distributor, or dealership.
- Check with your dealer in advance for any costs to you when arranging a warranty call. Mileage or service charges are not covered by this warranty. This charge can vary from store to store.

Index

Adjusting the Blower Speed (Optional).....	8	PB 36 Log Set Installation	14
Adjusting the Flame Height.....	8	PB 42 Log Set Installation	20
Before You Begin	6	Pilot Fuel Conservation Timer	9
Continuous Pilot / GreenSmart™ Pilot Switch ...	8	Power Outages	10
Features	3	Replacement Parts List.....	30
Glass Frame Removal and Installation	11	Rock Wool Placement	26
Heating Specifications.....	3	Starting the Fireplace for the First Time	7
Important Information	2	Starting the Heater for the First Time	10
Installation Warnings.....	2	Turning the Fireplace On and Off	7
Location of Controls	6	Wiring Diagram	31
Maintaining Your Heater's Appearance	27	Yearly Service Procedure	28
Normal Operating Odors	10		